

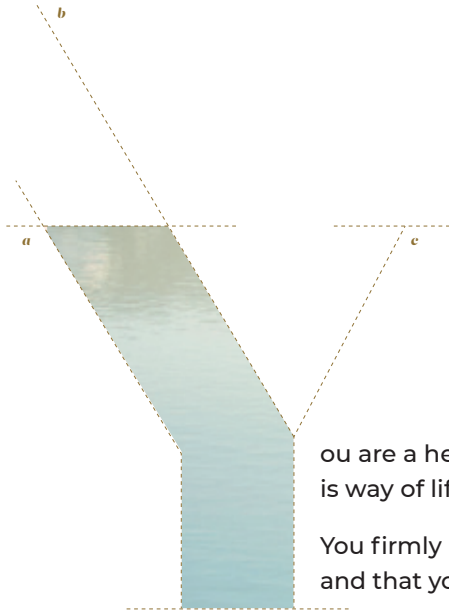

LE VOYAGEUR



EXCEPTION
IS OUR RULE



You are a hedonistic traveller: for you escape is an art of living and elegance is way of life.

You firmly believe that travel should always be an incomparable experience and that your destination is less important than how you get there.

For you, travelling is not just about getting from one place to another, but an art in itself. It is the art of moving in style, the art of living in the French manner but on the move, of enjoying life's pleasures and of making discoveries under the utmost conditions of comfort and safety.

The Heritage range, created in partnership with Mercedes, ensures that high standards and luxury are always part of the journey, while reliability and refinement accompany you every step of the way.

WITH
LE VOYAGEUR,
**THE EXCEPTION
IS THE RULE**



CONTENTS

10 / LE VOYAGEUR HERITAGE,
THE JOURNEY IS GREATER
THAN THE DESTINATION

38 / LE VOYAGEUR CLASSIC,
ELEGANCE THROUGHOUT
YOUR ENTIRE JOURNEY

70 / WORKING HAND IN HAND
TO BRING YOUR DREAMS TO LIFE

THE EXCEPTIONAL

IT'S WHAT WE DO

Driven by a deep desire to perpetuate the excellence of French craftsmanship, our employees have only one aim: to make the exception the absolute rule.

From the design office to the workshop, our motorhomes are exclusively designed and manufactured in Angers, in the west of France. Aerodynamics, ride comfort, handling and finish - for us, every little detail counts.

Thus 45 of our best experts work tirelessly to turn your dream of perfection into an equally extraordinary reality.

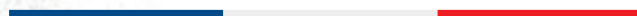



01



02

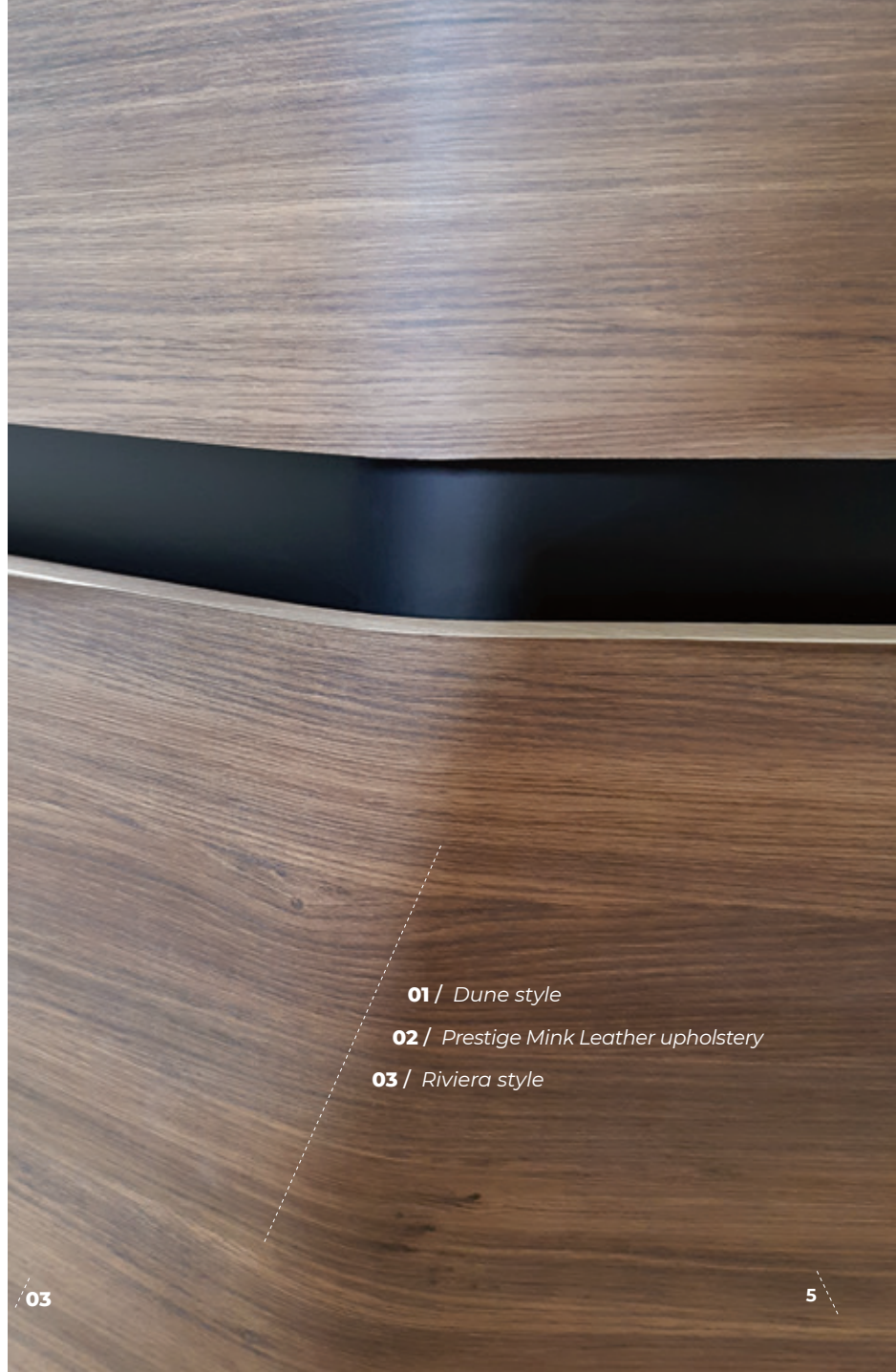

03

- 01 / *Dune style*
- 02 / *Prestige Mink Leather upholstery*
- 03 / *Riviera style*

5

OUT OF PASSION COMES **THE EXCEPTION**

Our Classic and Heritage ranges are born of a desire to create an exceptional vehicle wholly devoted to the satisfaction of our most demanding customers.

In the domain of the exceptional, however, know-how and technical mastery in themselves are not sufficient. What makes each of our motorhomes unique is not the purity of their design or the reliability of their technology.

Our work is exceptional because it is filled with soul. The soul of passionate people, ever willing to place their talent and high standards at the service of true perfection.



PAUL, **DREAM MAKER OF LE VOYAGEUR** **FOR THE LAST 5 YEARS**

“ *What I am passionate about in my job is building an exceptional prestigious product that will enable its owner to satisfy their desire to get away and travel. I feel that I am personally contributing to this dream in my own way.* ”



STÉPHANE,
CO-DESIGNER OF LE VOYAGEUR
FOR THE LAST 15 YEARS

“ It has always been my ambition to design a really meaningful product. Co-designing a Le Voyageur individually with each client ensures that every last detail of the design is exceptional and unique. I like to constantly challenge myself and imagin our clients' future living quarters, and above all, to share their pleasure in discovering each detail of their new travel companion.



MARIE,
PASSIONATE DESIGNER OF LE VOYAGEUR
FOR THE LAST 8 YEARS

“ I am happy to devote long hours to my passion, working and transforming materials. Shaping, sanding, taking the time to achieve a perfect finish so that each assembled part helps breathe life into every single Le Voyageur vehicle.

A MARRIAGE OF THE EXCEPTIONAL

The Heritage range marks the emergence of an outstanding motorhome on a Mercedes base vehicle.

It was a union full of promise: combining the power and reliability of German engines with the elegance and style of French design.

Le Voyageur Heritage will thus carry you to every corner of the world effortlessly and in complete safety.

But since you are a demanding traveller, it will also offer you top-of-the-range comfort and will imbue your journey with great looks.

1983



2000



2010



2021



*Our story started in 1981 with the first Le Voyageur 600 A-class model on a Mercedes-Benz base vehicle.
It continued in 1984/1985 with six new models on Mercedes-Benz chassis: LV 500, 510, 600, 605, 610 and 650.
This alliance continued until 2016 and today it begins anew with the Heritage range.*



LE VOYAGEUR

AA-123-AA 88



LE VOYAGEUR
Héritage

THE JOURNEY

IS GREATER THAN THE DESTINATION

You were delighted with this return to the roots and fundamentals of our brand, so we strove to fulfil your expectations: 40 years after the first model,

Le Voyageur is once more renewing its partnership with Mercedes to create the Heritage range.

A name chosen as a tribute to the shared past of two wonderful brands and to celebrate the start of our new adventure. More than ever, with this range the journey takes on a new dimension in which the destination is simply one part.

LUXURY

ON THE MOVE

Naturally, the furnishings and equipment are top-of-the-range, the materials are naturally noble, then there are the clean lines, the impeccable finishing and the fully customised interior...

But the real luxury is waking up in the soft light of early morning and looking out of the window of your bed at the sea. Walking across the sand on a deserted beach, having breakfast in the comfort of your own home, serenaded by the sound of the waves... Before taking to the road once more in search of a new setting for the evening, taking a break to explore a stunning village, meeting its inhabitants, savouring a local dish, and more.

Then, after a few zigzags, arriving at the top of the cliff to enjoy a dinner under the stars.



13 / LOUNGE

18 / KITCHEN

20 / BEDROOM

26 / BATHROOM

29 / THE LAYOUTS



LOUNGE

Because luxury is first and foremost a matter of space, everything has been designed to give you as much room as possible. Tables, benches, armchairs... everything has been specially designed to adapt to all possible situations and to accommodate up to 5 people in optimum comfort.

*Model shown:
LVXH 7.9 GJF*



- 01** / Model: LVXH 7.9 GJF
- 02** / Model: LVXH 8.7 CF
- 03** / Model: LVXH 8.7 CF





03





01 / Model: LVXH 8.7 CF

02 / Model: LVXH 8.7 CF

03 / Model: LVXH 7.9 GJF



KITCHEN

Cook just as you would at home in this bright, fully equipped kitchen. The numerous storage compartments and the large 153 L fridge allow you to store all the ingredients you need to prepare your favourite dishes effortlessly. And the two-burner hob will be enough to allow your culinary prowess to shine through.

01 / Model: LVXH 7.9 GJF

02 / Model: LVXH 7.9 GJF

03 / Model: LVXH 8.7 CF

04 / Model: LVXH 7.9 GJF





03



04



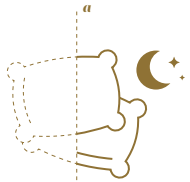

BEDROOM

Here everything is about luxury, calm and pleasure. Relax in your beautiful, spacious, fully equipped bedroom with optional TV screen. Whether on an island bed or twin beds, Bultex mattresses will guarantee you the best comfort and a perfect night's sleep.

*Model shown:
LVXH 7.9 GJF*





Model shown:
LVXH 7.9 GJF









Model shown:
LVXH 8.7 CF

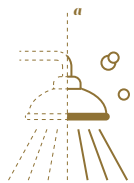

BATHROOM

After a day packed with chance encounters and discoveries, you can relax in your beautiful designer bathroom and enjoy the comfort of your 190 cm shower.

01 / Model: LVXH 7.9 GJF

02 / Model: LVXH 8.7 CF

03 / Model: LVXH 7.9 GJF



01



TRAVELLING IN SPACE

Luxury is being able to travel without constraint and move freely. At the very least, the Heritage range will ensure that you are totally free in your movements. Indeed, this is a range that thinks big and has been designed to offer you the maximum amount of space possible. Like a yacht, its numerous ergonomic storage spaces free up space to create real living areas entirely separate from one another.

In the 7.9, as in the 8.7, you will have the sensation of moving around as if in real rooms, and their fully modular interiors can be adapted to meet your every wish.

Whichever layout you choose, whether an island bed or twin beds, the Heritage range offers the luxury of travelling with a generous sense of space.



LV^a XH 7.9

HEAVY VEHICLE:
4500 kg / double axle / 7.91 m



🌐 LVXH 7.9 CF



🌐 LVXH 7.9 GJF

LV^a XH 8.7

HEAVY VEHICLE:
5500 kg / triple axle / 8.75 m



🌐 LVXH 8.7 CF



🌐 LVXH 8.7 GJF



STREAMLINED DESIGN

The elegant curves and harmonious lines from the front to the rear of the vehicle lend a dynamic appearance to your Le Voyageur motorhome. The interior design is clean and functional, while the noble materials and the impeccable finish are the hallmarks of a top-of-the-range vehicle.



- One-piece polyester front and back
- 3 m high
- 2.3 m wide

A TRULY EXCEPTIONAL STRUCTURE

To live your journey to the fullest, you must set off with a free mind and with complete confidence in your travelling companion. The Mercedes Sprinter engine combined with an AL-KO chassis offers you the best possible pairing of reliability and robustness to take you wherever your dreams lead.



1 ALLYING POWER AND TECHNOLOGY:

A Mercedes Sprinter engine coupled with an AL-KO chassis to give:

- unrivalled robustness
- uncompromising reliability
- improved stability
- greater width
- lower ground clearance
- Euro VI D certification: Heavy duty

2

THE WALLS

This robust insulation lets you enjoy your motorhome year-round.

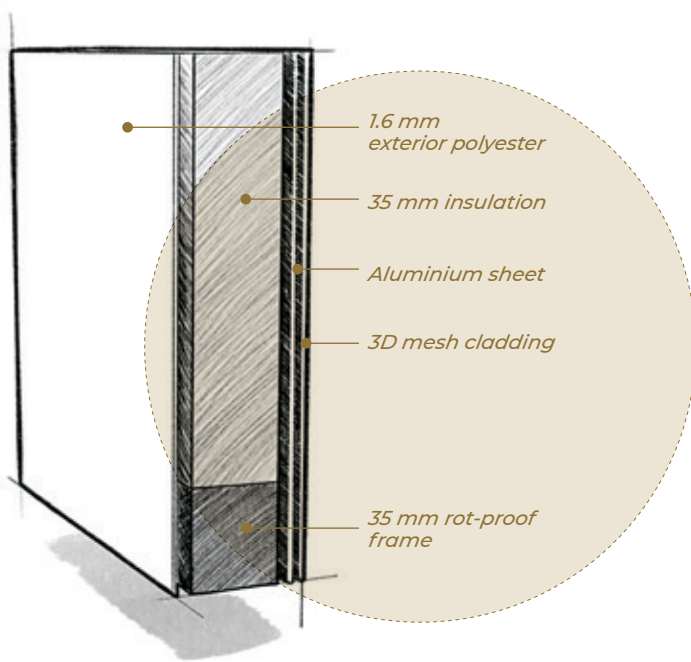

3

THE FLOOR

Smart, insulating double floor: the fresh and waste water tanks are protected from freezing and space is maximised. Thanks to its 26 cm height, many parts can be stored in the floor.

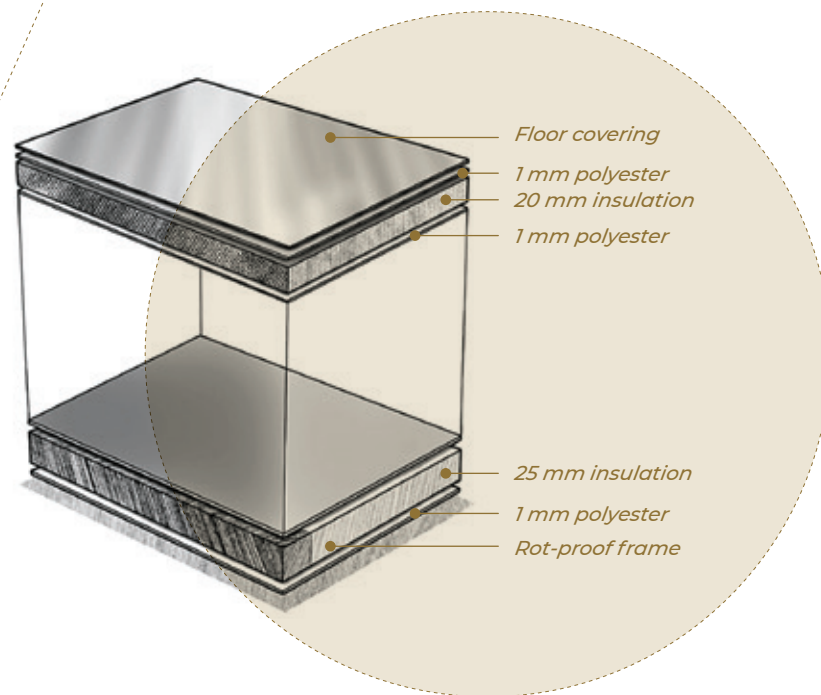

INCOMPARABLE

DRIVING COMFORT

Driving will quickly become one of the key pleasures of your trip as the Heritage range offers you the very best in everyday driving comfort.

Your place behind the wheel becomes a real cockpit from which you can control every setting that will make your journey enjoyable and safe.

And to enhance your safety and peace of mind, every feature possible has been automated, from turning on the lights to adaptive cruise control.

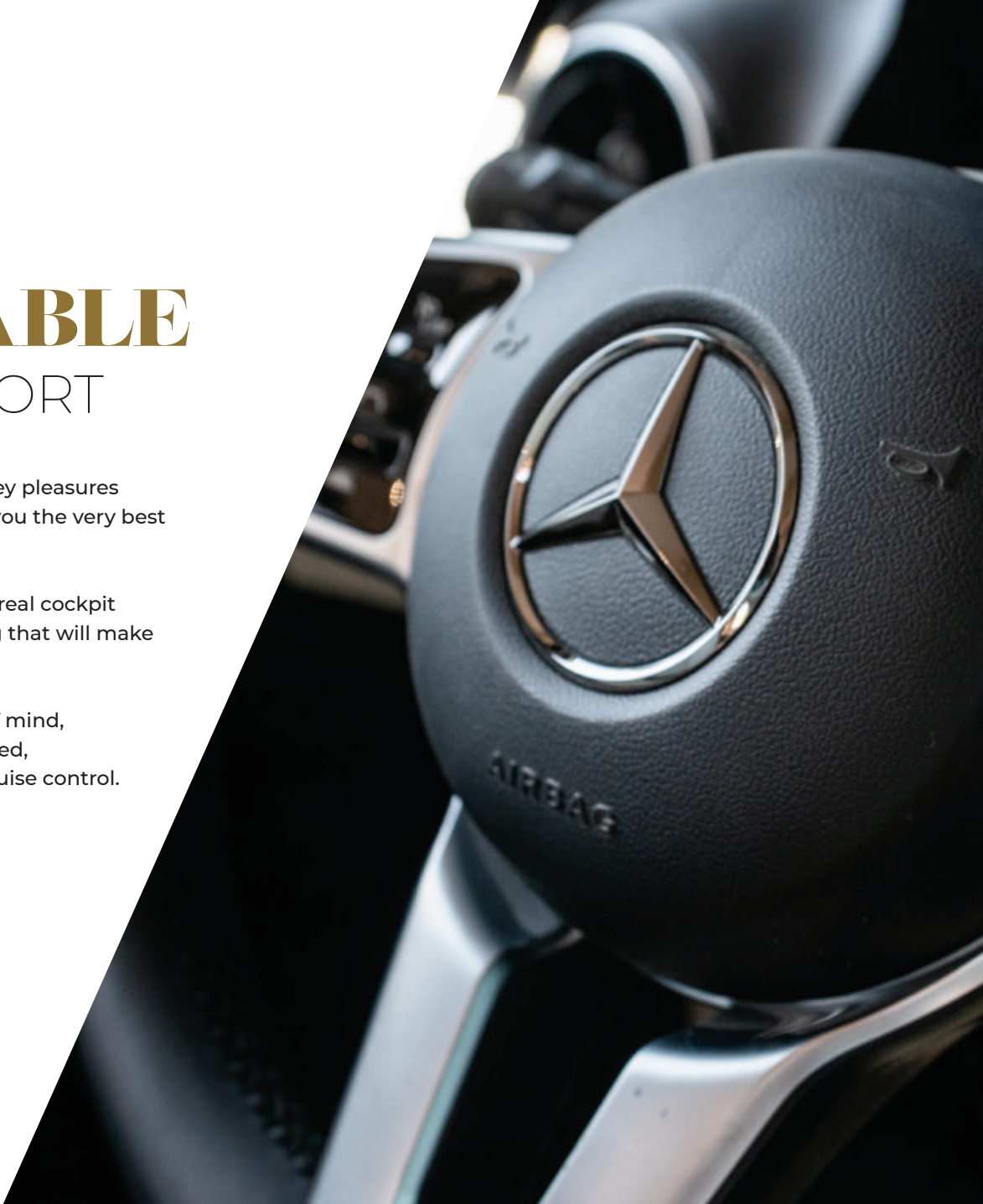



- 4-cylinder 2.2 litre engine, 150 hp standard, 170 hp 2-litre optional
- 6-speed manual gearbox or optional "9G-TRONIC" automatic gearbox
- Driver and passenger airbags as standard
- EPS emergency braking
- 90-litre fuel tank as standard
- ABS
- Start and stop system
- Attention Assist (detects signs of driver fatigue)
- Crosswind stabilisation system
- LED front and rear lights
- Electric hand brake
- Automatic headlights
- 3 sensors connected to the airbags to allow the vehicle to be stopped in the event of danger, automatic headlights, with optional distance control
- Reversing camera: long-distance and wide-angle view
- SKA heated seats with adjustable position and 120 mm of travel
- Semi-automatic air conditioning as standard or automatic as an option
- Multifunction steering wheel
- Automatic windscreen wipers

A CONNECTED VEHICLE

Whether you choose the **MBUX system** – a true artificial intelligence system that intuitively adapts to your habits and behaviour, the **FULL BOX** – which allows you to monitor the key parameters of your motorhome –, or the **DRONE VIEW** driver assistance system (option) – which gives you a 360° view exactly as if a drone was hovering above your vehicle, the Heritage range offers you the most high-tech equipment in the sector, in keeping with its high-end market position.



1

THE MBUX SYSTEM

- Controlled via the multifunction steering wheel, touch screen, or buttons below the screen
- 7-inch touchscreen as standard, or 10-inch screen with GPS as an option
- Smartphone integration: Android Auto, Apple CarPlay
- Hands-free function via Bluetooth interface
- USB interface

2

FULL BOX A SPACE THAT ENABLES YOU TO MONITOR ALL KEY DATA FOR YOUR VEHICLE

- Real-time water level tracking
- Battery charge tracking
- Air conditioning and precise heating management with setting (to the nearest degree)
- Vehicle lighting and auxiliary device management

3

360° CAMERA WITH DRONE VIEW

- 7-inch portrait screen or 8-inch landscape screen with dynamic view in addition to drone view
- 4 x 180° high-definition cameras on all 4 sides of the vehicle
- A computer-generated image of the actual vehicle on the screen gives the illusion that a drone is hovering overhead
- No more blind spots at ground level under any conditions
- Optional dashcam feature
- May also be used as a video surveillance system during the day and at night (night vision).



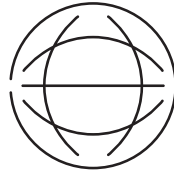

LE VOYAGEUR
Classic

ELEGANCE THROUGHOUT YOUR ENTIRE

JOURNEY

The Classic range has been created for those who consider elegance to be an essential part of travel since it offers the best way to enjoy each moment. For this reason, with its harmonious curves on the outside and its sleek interior design, the Classic range allows you to discover the world in style.

FREEDOM WITH **FETCHING LOOKS**

Despite its prestige and high-class standing, freedom is perhaps the greatest luxury that Le Voyageur has to offer you. Immediately from the outset, depending on whether you turn right or left at the end of your street, you will discover completely different countries and cultures.

Scrambled eggs and smoked fish by a Scandinavian lake or chocolate con churros in Spain? Do you prefer to drive along the coast with the sea to your side or do you favour taking the back roads to discover small villages? Do you like to dine in the warmth of your living room on the edge of a forest or under the stars, with the beach as your terrace?

Le Voyageur offers you the luxury of considering all options safely, reliably, and always with French chic.



41 / LOUNGE

46 / KITCHEN

50 / BEDROOM

54 / BATHROOM

59 / THE LAYOUTS



LOUNGE

Your spacious and fully modular living area, whether arranged in an L-shape or two facing sides, can be adapted to fit every situation. The bench and folding table can accommodate up to 6 people. Ideal for a meal with friends or family.



01 / Model: LV 7.2 GJF

02 / Model: LV 7.5 GJF





01 / Model: LV 7.5 GJF

02 / Model: LV 7.2 GJF

03 / Model: LV 7.8 GJF



01

- 01 /** Model: LV 7.8 CF
- 02 /** Model: LV 7.8 GJF
- 03 /** Model: LV 7.8 CF



02



03



KITCHEN

Enjoy the pleasure of cooking in a bright and fully equipped space. The large automatic refrigerator with double doors and the numerous soft-close drawers can easily hold all your ingredients. The large, well-lit laminate worktop and 2-burner hob allow you to prepare recipes worthy of a gourmet restaurant.

01 / Model: LV 7.8 GJF

02 / Model: LV 7.8 CF

03 / Model: LV 7.8 GJF

04 / Model: LV 7.8 CF





03



04



- 01 /** Model: LV 6.8 LF
- 02 /** Model: LV 7.2 GJF
- 03 /** Model: LV 7.5 GJF



01





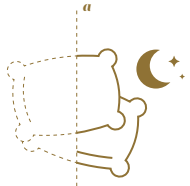

BEDROOM

Enjoy a peaceful night's sleep in a spacious, fully equipped bedroom. Take advantage of the ample storage capacity with large wardrobes that light up automatically on opening. Whether on an island bed or twin beds, Bultex mattresses will guarantee you beautiful journeys to the land of dreams.

01 / Model: LV 7.8 CF

02 / Model: LV 7.8 GJF



02

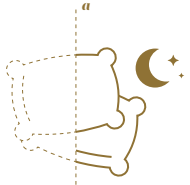

01



02

01 / Model: LV 7.8 GJF

02 / Model: LV 7.8 GJF

03 / Model: LV 7.5 GJF



03

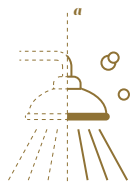

BATHROOM

After an event-filled day, enjoy a moment of relaxation in your beautifully designed bathroom. The 190 cm shower gives you all the comfort you need to recharge your batteries.

- 01 /** Model: LV 7.8 CF
- 02 /** Model: LV 7.2 GJF
- 03 /** Model: LV 7.5 GJF





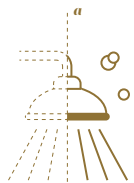

- 01** / Model: LV 7.8 CF
- 02** / Model: LV 7.5 GJF
- 03** / Model: LV 7.8 CF



01



02



03

LET YOURSELF BE CARRIED ALONG

Light and compact, the LV 6.8 LF and LV 7.2 motorhomes will always get you to your destination in style. With its spacious living areas, the LV 6.8 is a real mini-loft, ideal for two people travelling together. Available with either an island bed or twin beds, the LV 7.2 combines all the quality and comfort of French luxury in a perfectly functional format.

The LV 7.5 is the perfect combination of high comfort and simple mobility. The separation of its different living spaces lends an apartment feel, as if to invite you to adopt this motorhome as your second home.

With an exceptional payload of 1,000 kg, this luxury travel heavyweight nevertheless remains easy to manoeuvre.



LV

6.8 LIGHT VEHICLE:
3500 kg / Single axle / 6.80 m
4,500 kg (option)



 LV 6.8 LF

LV

7.2

LIGHT VEHICLE:
3500 kg / Single axle / 7.25 m
4,500 kg (option)



LV 7.2 CF



LV 7.2 GJF

LV

7.5

HEAVY VEHICLE:
4500 kg / Single axle / 7.55 m



LV 7.5 CF



LV 7.5 GJF



LUXURY IN THE PERFECT **PROPORTION**

Do you dream of wide open spaces, exceptional panoramas and comfort rivalling that of your own home? Your LV 7.8 can offer you all this and much more.

The interior is fully modular and can be adapted to your needs thanks to a wide range of layouts. With its many ergonomic storage compartments, you can take everything you need along with you, without the slightest hesitation.

LV^a

7.8 HEAVY VEHICLE:
4500 kg / Single axle / 7.85 m



🌐 LV 7.8 CF



🌐 LV 7.8 CL



🌐 LV 7.8 GJF



🌐 LV 7.8 GJL



🌐 LV 7.8 JF



🌐 LV 7.8 LU

TRAVEL BEYOND THE HORIZON

The LV 8.5 owes its nickname of Le Prestige to its ability to consistently make you think big. With four different layouts, an XL garage, and a dining area that seats 6 guests, the 8.5 lives for large spaces.

With supreme safety through the stability of its double axle, it offers unequalled comfort thanks to the magnificent spaciousness of its living areas.



LV^a

8.5 HEAVY VEHICLE:
5000 kg / Double axle / 8.55 m



🌐 LV 8.5 CF



 LV 8.5 CL



 LV 8.5 GJF



 LV 8.5 GJL





REDESIGNED **DRIVING COMFORT**

With the range of Fiat Euro 6D engines (from 140 hp to 180 hp) on AL-KO chassis and the new 9-speed automatic transmission, taking to the road becomes a real pleasure.

Greater power, thanks to an even higher level of torque (up to +12.5 %), coupled with more economical and environmentally friendly driving as a result of its VGT (Variable Geometry Turbo).

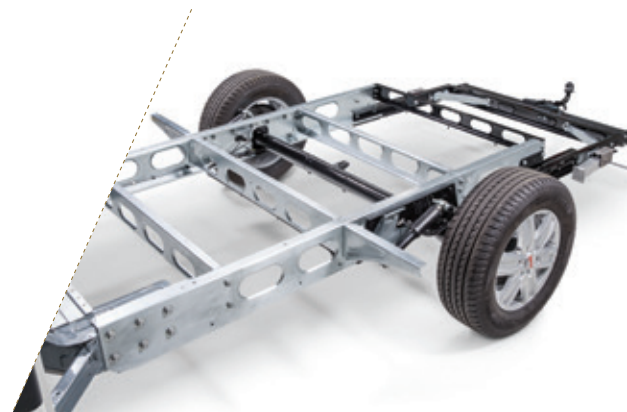

INTELLIGENT DESIGN

The intelligent double floor of your Classic motorhome protects you from the cold providing optimum comfort in all seasons. In addition to protecting the fresh and waste water tanks from freezing, this 26 cm-deep double floor provides storage for numerous items, thus freeing up a maximum of space inside your Le Voyageur.

Walls made of aluminium, among other materials, offer 30 % greater heat diffusion than plywood.

1 TRAVEL FAR AND WIDE, FOR LONG SPELLS IN ANY SEASON

Enjoy additional storage space and easy and safe access to the entire electrical system.

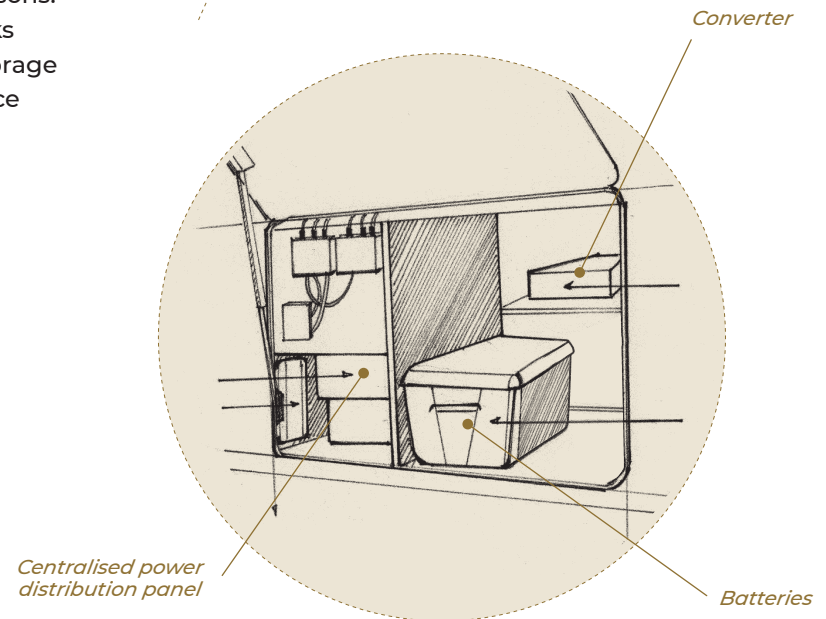

2

A DOUBLE MULTIFUNCTION FLOOR

The double floor, which is heated and isolated stores heat and releases it in the same way as underfloor heating.

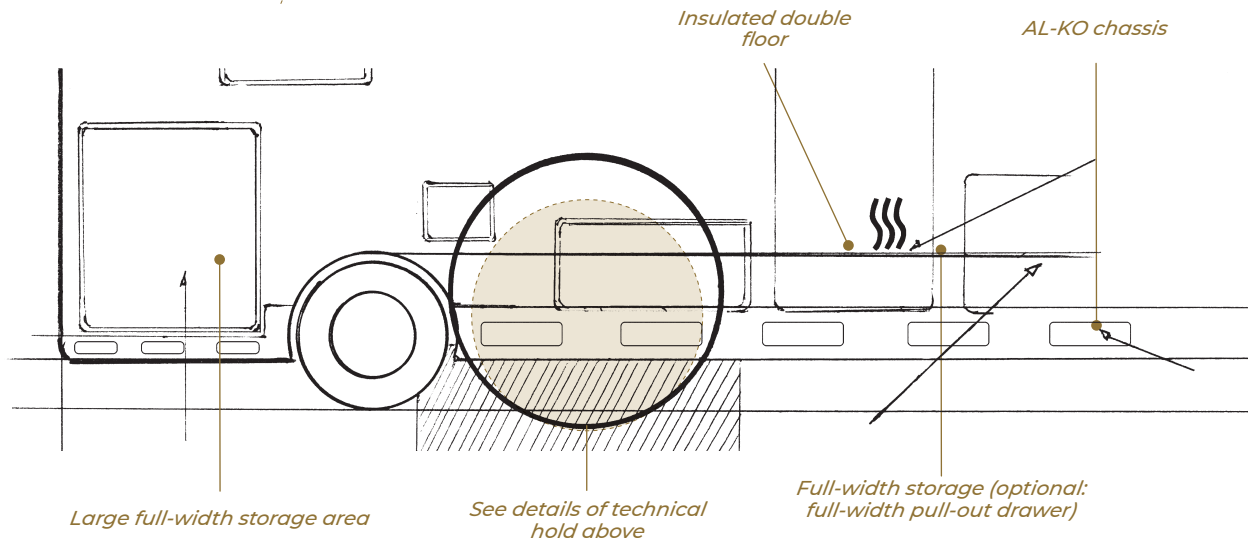

COMFORT AND SAFETY

French luxury combined with technical expertise to offer you well-being, durability and safety throughout your journey.

1

CONTROL PANEL

Opt for a single central control panel to operate all vehicle functions:

- ON/OFF switch (heating, lighting, radio, TV, USB ports and 12 V water pump).
- Separate lighting level controls for each area.
- Information on autonomy levels (fresh water, waste water and leisure battery levels).
- Truma®/Alde® heating system controls (with temperature, hot water, electricity and gas settings).

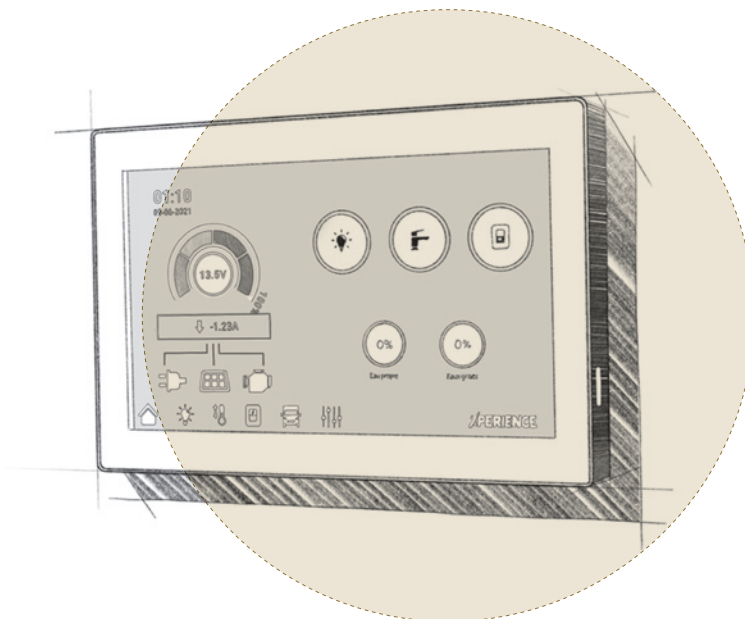

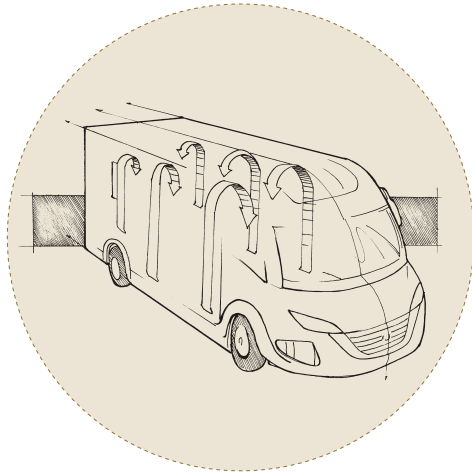

2

CLASS 3 INSULATION

Le Voyageur is certified Class 3, the highest level of insulation available as tested and validated by Truma® and Alde®. The indoor temperature can go from -15°C to 20°C in 4 hours.

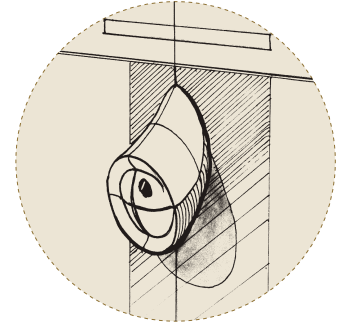

Wide-angle reversing camera

3

OPTIMAL VISIBILITY

The system comprises an onboard camera for each wing mirror and a control screen that divides in four. The vehicle's rear-view camera is also connected to this display.

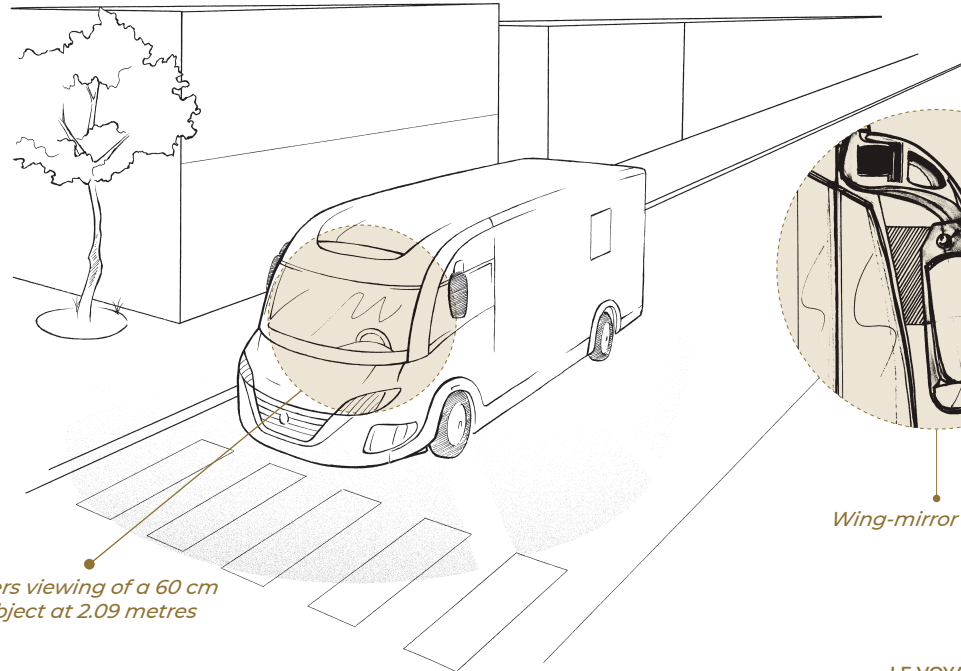

Offers viewing of a 60 cm object at 2.09 metres

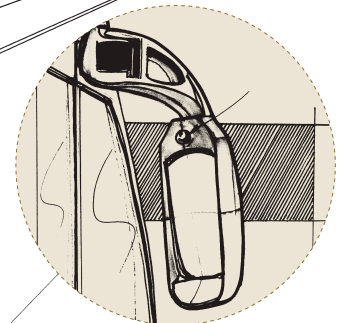

Wing-mirror camera



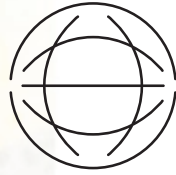

LE VOYAGEUR

WORKING HAND IN HAND

TO BRING YOUR DREAMS TO LIFE

Tell us about your dream motorhome and we will build it for you. To ensure that it truly reflects your image and makes you feel entirely comfortable, we offer you the possibility of customising it. Together, let us take the time to determine the characteristics of your ideal travel companion: layouts, interior design, finishes... From the moment it is built and throughout the life cycle of your vehicle, we are continually at your side.

LUXURY

AT ITS VERY BEST

Whatever Le Voyageur you decide on, the ambience inside your motorhome will be welcoming. The natural, textured Riviera wood or the blond Dune wood give your interior a comforting softness.

01 / *Dune style*

02 / *Riviera style*



DUNE



RIVIERA



01



02

BEAUTY IS ALSO WITHIN

To create an interior that reflects who you are and makes you feel completely at ease, we offer a wide choice of colours and premium upholstery materials.

01 / *Prestige satin*

02 / *Prestige vison*



01



02



**CHARM
SATIN**

Imitation leather
(option)



**PRESTIGE
SATIN**

Full leather
(option)



**CHARM
CASHMERE**

Imitation leather (option)



**PRESTIGE
VISON**

Full leather (option)



**FABRIC
FLANNEL**



LE VOYAGEUR

EXCEPTION
IS OUR RULE

Legal information - Groupe Pilote, Route du demi-bœuf - 44310 La Limouzinière - SARL with a capital of 20,000,000 euros, registered with the Nantes commercial and companies registry under No. B872 802 780. Siren: 872,502,780. Note - This brochure corresponds to the information known at the time of printing and is not a contractual document. Despite the care taken in the production of this document, printing errors are possible. We reserve the right to make equipment changes or product improvements to the current year's models without prior notice. Some of the vehicles are shown with special or optional equipment, which are listed in the relevant price lists and available at an extra charge. The styling and decorative elements used to decorate the images in this catalogue are not part of the vehicle and delivery service.

The available payloads are calculated from the difference between the technically permissible maximum weights and the weights in running order. The latter include the weight of the driver (75 kg), 20 L of clean water, 90% of fuel and 100% of gas. They only take into account the standard equipment at the factory. A difference of +/- 5% on the mass in running order is tolerated by European regulations. The manufacturer reserves the right to change this. The capacity of the clean water tank determined for the calculation of the mass in running order is 20 L. This is in accordance with the regulations and in particular the number of road seats defined at the time of approval. It is the user's responsibility to adapt his load and the number of people on board according to the payload of his vehicle, in compliance with the maximum technically admissible masses in total and per axle. If necessary, the user may choose to limit his load or the number of persons carried in order to increase his clean water capacity beyond this value. The maximum clean water capacity is the one defined for each vehicle in the "autonomy" paragraph. Please note: additional equipment and accessories fitted as optional extras are not included in the mass in running order of the motorcaravan. This means that the available payloads and, where applicable, the road space, are always reduced.

Your dealer will be pleased to inform you about the exact definition of the models available in each country. Before placing your order, please ask your dealer about the current status of the product and the collection. The information on delivery, appearance, performance, dimensions and weight of the vehicle correspond to the data known at the time of printing. These specifications and their tolerances are in accordance with European regulations (Regulation (EU) 1230/2012) and are subject to change until the vehicle is purchased or delivered.